

CONF-8609162--1

Los Alamos National Laboratory is operated by the University of California for the United States Department of Energy under contract W-7405-ENG-38.

LA-UR--86-3319

DE87 000164

TITLE: LARGE EXCIMER LASERS FOR FUSION

AUTHOR(S): Jensen, Reed J.

SUBMITTED TO: Society of Photo-Optical Instrumentation Engineers
Bellingham, WA

DISCLAIMER

This report was prepared as an account of work sponsored by an agency of the United States Government. Neither the United States Government nor any agency thereof, nor any of their employees, makes any warranty, express or implied, or assumes any legal liability or responsibility for the accuracy, completeness, or usefulness of any information, apparatus, product, or process disclosed, or represents that its use would not infringe privately owned rights. Reference herein to any specific commercial product, process, or service by trade name, trademark, manufacturer, or otherwise does not necessarily constitute or imply its endorsement, recommendation, or favoring by the United States Government or any agency thereof. The views and opinions of authors expressed herein do not necessarily state or reflect those of the United States Government or any agency thereof.

By acceptance of this article, the publisher recognizes that the U.S. Government retains a nonexclusive, royalty-free license to publish or reproduce the published form of this contribution, or to allow others to do so, for U.S. Government purposes.

The Los Alamos National Laboratory requests that the publisher identify this article as work performed under the auspices of the U.S. Department of Energy

MASTER

Los Alamos Los Alamos National Laboratory
Los Alamos, New Mexico 87545

gthp

Large Excimer Lasers for Fusion

Need J. Jensen

Los Alamos National Laboratory
Los Alamos, New Mexico 87545

Introduction

Important goals in DOE and DoD programs require multimegajoule laser pulses. For inertial confinement fusion there is also a requirement to deliver the pulse in about 25 nsec with a very particular power vs time profile--all at high overall efficiency and low cost per joule. After exhaustive consideration of various alternatives, our studies have shown that the most cost effective approach to energy scaling is to increase the size of the final amplifiers up to the 200 to 300 kJ level. This conclusion derives largely from the fact that, at a given complexity, costs increase slowly with increasing part size while output energy should increase dramatically. Extrapolations to low cost by drastic cuts in the unit cost of smaller devices through mass production are considered highly risky. At a minimum the requirement to provide, space, optics and mounts for such systems will remain expensive.

In recent years there have been dramatic advances in scaling. The Los Alamos LAM has produced over 10 kJ in a single 1/2 nsec pulse. In this paper we explore the issues involved in scaling to higher energy while still maintaining high efficiencies. In the remainder of this paper we will discuss KrF laser scaling for the fusion mission. We will omit most of the discussion of the laser system design, but address only KrF amplifiers.

Scaling

Fig. 1 shows the relationship between laser cost and the cost of electricity.¹ It is easily seen that for driver cost of \$200/J and efficiency greater than 5% favorable electrical costs are possible. Fig. 2 shows how laser system cost decreases with module size and total driver energy. Module sizes less than 100 kJ are probably uneconomic because of the very large number of beam lines needed. Arguments for unit cost reduction because of large quantities are considered very tenuous at least until the specific design is known in great detail.

In constructing a very large amplifier it is very advantageous to adopt a modular design. In this scheme the amplifier is produced by stacking a sufficient number of modules. Fig. 3 shows the electron beam pumping footprint for several design options.² The most favorable of these is the segmented expanding flow diode system.

Fig. 4 shows more detail for the system. The expanding flow pattern for the emitted electrons allows for close stacking of the diode structures and better uniformity of the pumped medium. The high voltage mechanical support bushings are of a new design and will require development. Fig. 5 shows how the > 100 kJ amplifier is integrated from its components. At Los Alamos we, along with AVCO Everett, have completed the design for such an amplifier. It is referred to as the power amplifier module or PAM. Some parameters of the system are shown in Figs. 6 and 7. Fig. 8 shows one of the ten diode modules to be stacked together to constitute the PAM system. Notice that the segment is over 2 meters high, but services an electron window area only 60 cm wide. This arrangement makes it possible to achieve the total pump current required and yet control electron beam pinch with applied magnetic fields of only a few kG. This overall approach to scaling incorporates enough adjustable parameters to assure scaling to the levels required by the application. A related issue is amplifier energy efficiency.

Efficiency

Fig. 9 shows the anticipated improvements in KrF amplifier efficiency when the intended technology improvements are incorporated. Improvement in electron optics should result in an overall efficiency of 5.8% instead of the present 3.5%. The 5.8% should then improve to 10.2% by using both higher mole percent Kr and higher extraction intensity to thwart the formation of Kr₂F.

The main idea behind the attempt to improve electron optics is to prevent absorption by electron window supports. This is to be done by designing the emitter surface to emit only in areas that map into high transmission areas for the electron window. To do this, account must be taken of pattern rotation caused by the self field of the emission. Also technology must be developed to allow non emission in the areas intended not to emit.

Fig. 11 shows the salient excitation paths to the upper laser level, and some paths to formation of performance degrading species. It must be stressed that unless the extraction intensity is sufficiently high, no performance improvement will be observed for Kr rich mixtures. Fig. 10 shows how extraction efficiency improved with g_0/α where g_0 is the small signal gain and α is the nonsaturable absorption. Once the electrical performance of the system is perfected, the system efficiency becomes very sensitive to nonsaturable absorption that inevitably arises from F^- and some Kr_2F .

However, the notorious absorber Ar_2a is purposely omitted. Performance is also easily degraded by a host possible fluoride impurities. Highest efficiencies can be expected only when the gas handling system is totally stabilized and debugged, and the absence of unwanted absorbers is confirmed.

LAM

The large aperture module (LAM) represents a first obvious step toward scaling of KrF lasers for fusion. In that project there was no attempt to advance the state of the art of a beam driven amplifiers. Rather it was only an effort to apply known technology to the KrF system at an affordable cost. That device has produced over 10 kJ in a 600 ns pulse and has laid the foundation for designs that scale to larger outputs.²

References

1. Harris, D. B., Berggren, R. R., Kurnit, N. A., Los Alamos National Laboratory, Lowenthal, D. D., Berger, R. G., Eggleston, G. B., Ewing, J. J., Kushner, M. J., Spectra Technology, Inc., Waganer, L. M., Bowers, D. A., Zuckerman, D. S., McDonnell Douglas Astronautics Company, Future Developments and Applications of KrF Laser-Fusion Systems, LA-UR-86-1837, Los Alamos National Laboratory.
2. Sullivan, J. A., KrF Power Amplifier Module Scaling", Fusion Technology, accepted for publication.
3. Jensen, R. J., Rosocha, L. A., Sullivan, J. A., High Power KrF Lasers for Fusion, Los Alamos National Laboratory.

LASER SYSTEM COST DECREASES FOR LARGE AMPLIFIER MODULES AND HIGHER ENERGY ON TARGET

200 kJ AMPLIFIER MODULES REAP MOST OF THE COST ADVANTAGE OF SIZE

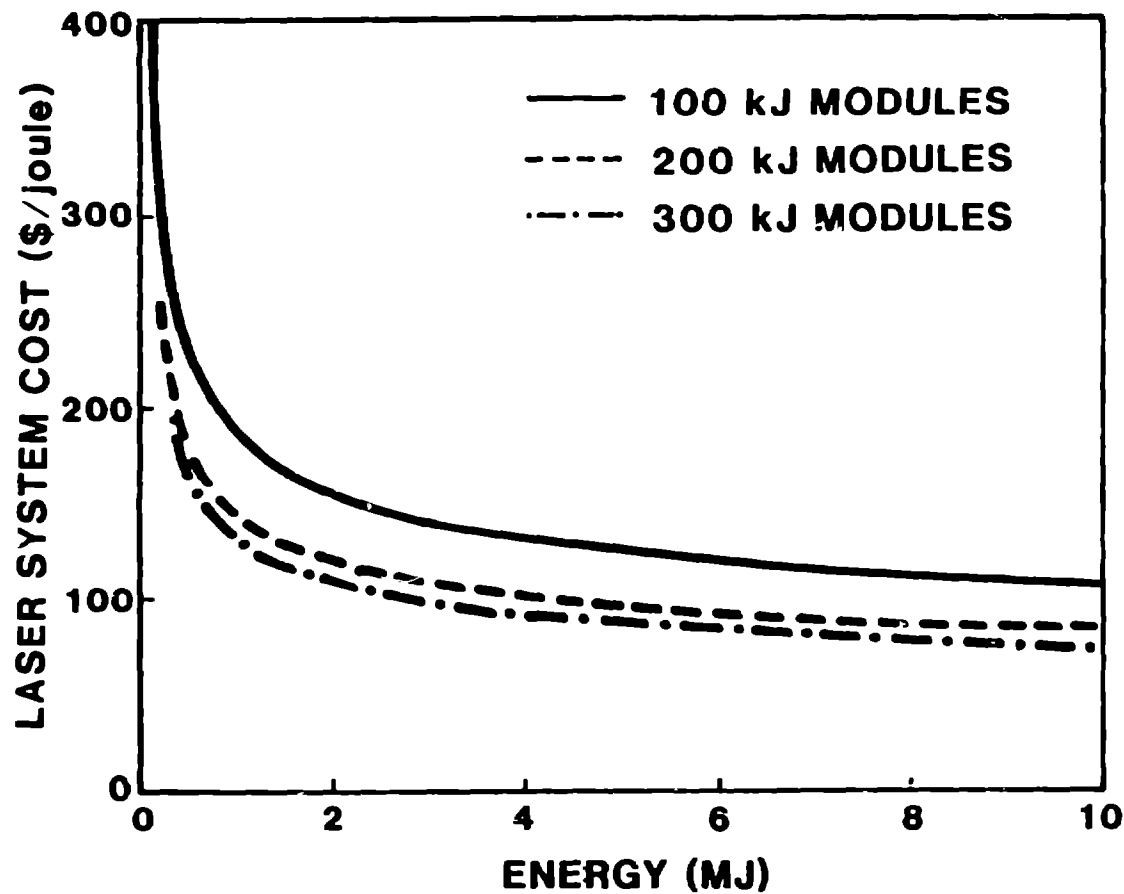

DIODE TECHNOLOGY CHOICES

- **MONOLITHIC**

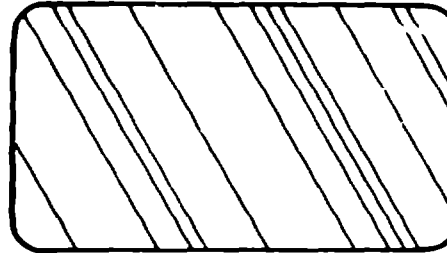

ISSUES

- B-FIELD REQUIRED $B \propto J h/2$
- FORMATION OF STREAMERS
- HIGH CLOSURE VELOCITIES
- MFG/MAINTENANCE/REPAIR
- HIGH RISK/HIGH COST

- **SEGMENTED PLANAR WITH APPLIED FIELD**

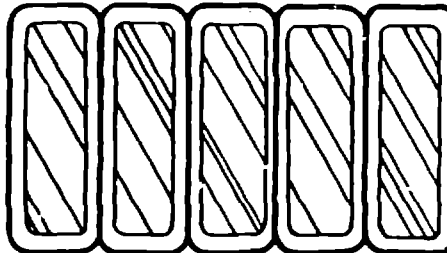

- EXCESSIVE UNPUMPED REGIONS (standoff plus return)
- LOW η APPROACH

- **SEGMENTED PLANAR, NO APPLIED FIELD**

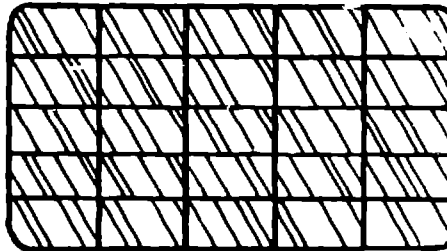

- SELF-PINCH LIMITS SIZE
- MANY DIODES REQUIRED
- MAINTENANCE/REPAIR

- **SEGMENTED EXPANDING FLOW**

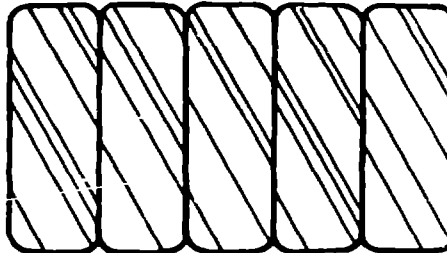

- EMISSION CONTROL
- B-FIELD SHAPING
- BUSHING AND SWITCH DESIGNS

AVCO/LANL SEGMENTED EXPANDING FLOW DIODE DESIGN

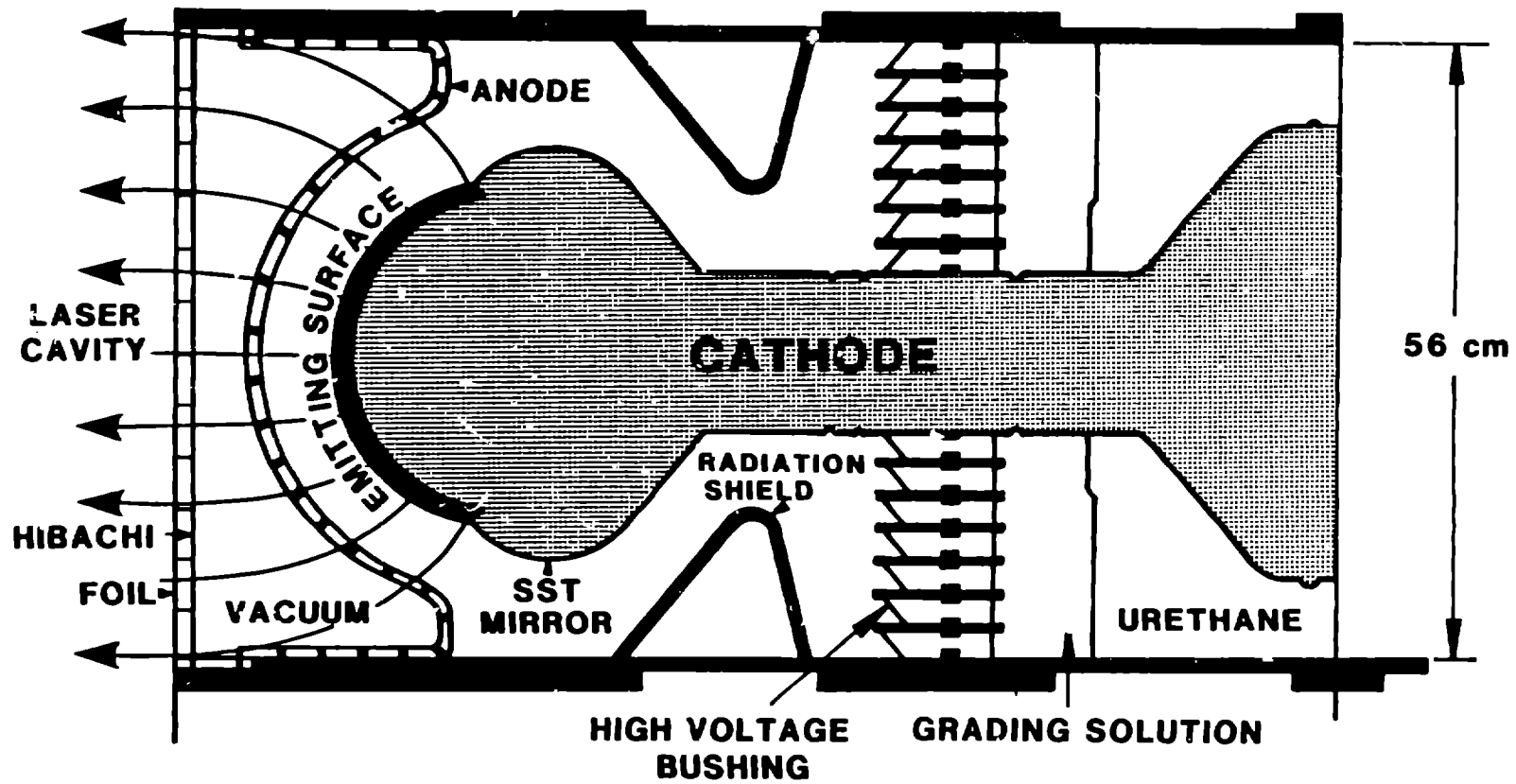

LARGE K_rF AMPLIFIER TECHNOLOGY REQUIRES ADVANCEMENT AND DEMONSTRATION IN THE FOLLOWING AREAS

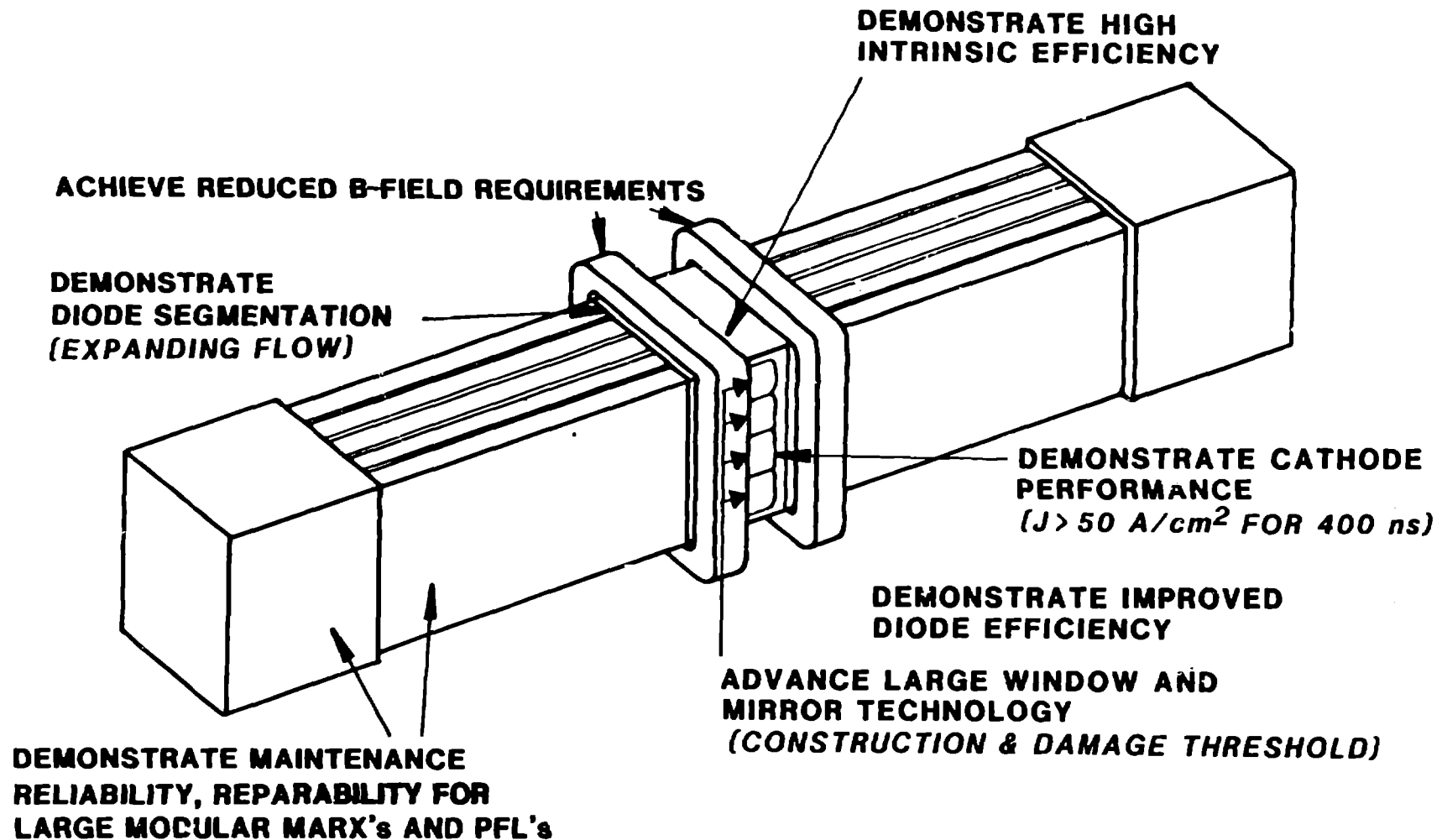

PAM LASER CAVITY PREDICTED AND SPECIFIED PERFORMANCE PARAMETERS

<i>PARAMETERS</i>	<i>VALUE</i>
PULSE LENGTH	400 ns
RISE TIME	≤ 45 ns
PEAK POWER DEPOSITED	250 kW/cm³
PRESSURE	585 Torr
Kr/F₂ RATIO	250
OUTPUT COUPLING (start up)	0.84
GAS TEMPERATURE (initial)	300 K
OUTPUT ENERGY	> 100 kJ
FORMATION EFFICIENCY	> 26%
EXTRACTION EFFICIENCY	> 50%
INTRINSIC EFFICIENCY	> 13%

PAM DESIGN SPECIFICATIONS

ENERGY OUTPUT	~ 100 kJ
PULSE LENGTH	400 ns
OUTPUT FLUENCE	$< 3.5 \text{ J/cm}^2$
LASER CAVITY DIMENSIONS	$h = 325 \text{ cm}$ $w = 130 \text{ cm}$ $L = 300 \text{ cm}$
GUIDE FIELD MAGNETIC STRENGTH	1.5 - 3 TIMES B_{self}
RISE TIME/FALL TIME LOSSES	$\leq 20 \text{ PERCENT}$
RISE TIME	$\leq 45 \text{ ns}$
OVERALL EFFICIENCY	3 - 5 PERCENT
KRYPTON-RICH MIX OPERATING AT 585 TORR	-----
PUMPING POWER (average)	250 kw/cm^3
USE A SEGMENTED MIRROR AND OUTPUT WINDOW	-----
THE AMPLIFIER WILL OPERATE PARASITIC FREE	-----
ASE LOSS	$< 10 \text{ PERCENT}$
INSTANTANEOUS VOLUMETRIC PUMPING UNIFORMITY PARALLEL TO THE LASING DIRECTION	$\pm 10 \text{ PERCENT}$
VOLUMETRIC PUMPING UNIFORMITY OVER THE DURATION OF THE USEFUL PUMP PULSE PARALLEL TO THE LASING DIRECTION	$\pm 10 \text{ PERCENT}$
RELIABILITY GOAL	1 FAILURE/300 SHOTS
MAXIMUM TIME TO REPAIR FOR ANY ONE FAILURE	TWO WEEKS

THREE-DIMENSIONAL CUTAWAY
OF THE PAM PROTOTYPE DIODE

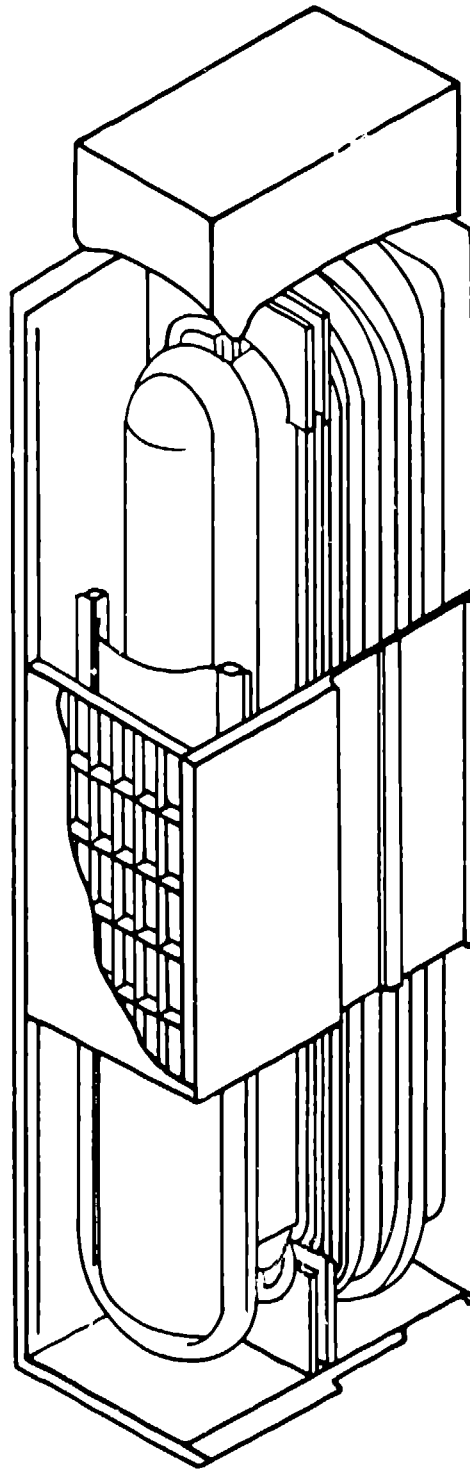

DEFINITE STEPS WILL IMPROVE KRF EFFICIENCY

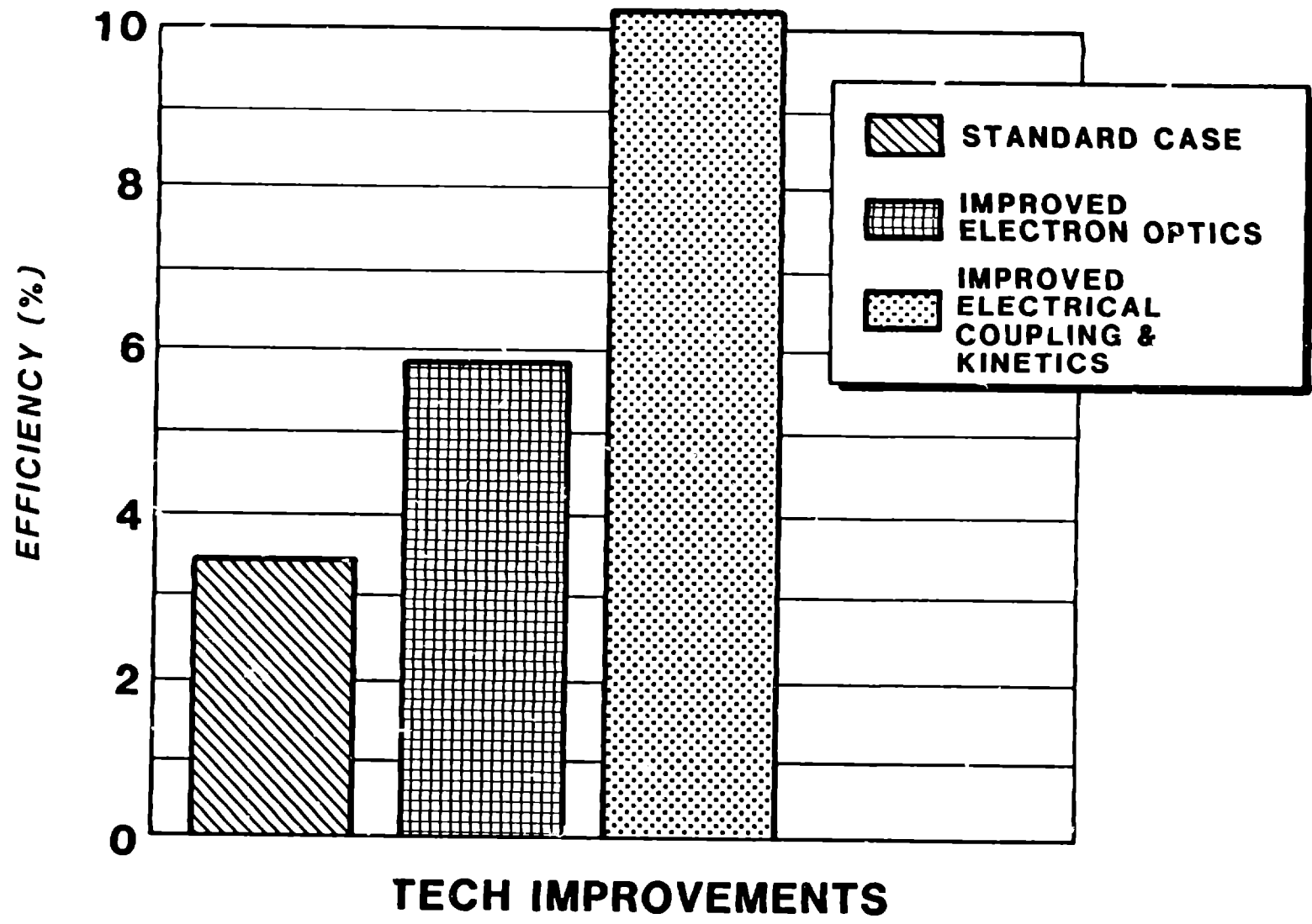

MAJOR IMPROVEMENT IN KrF EFFICIENCY HAS RESULTED FROM ADJUSTING Kr/Ar MIX

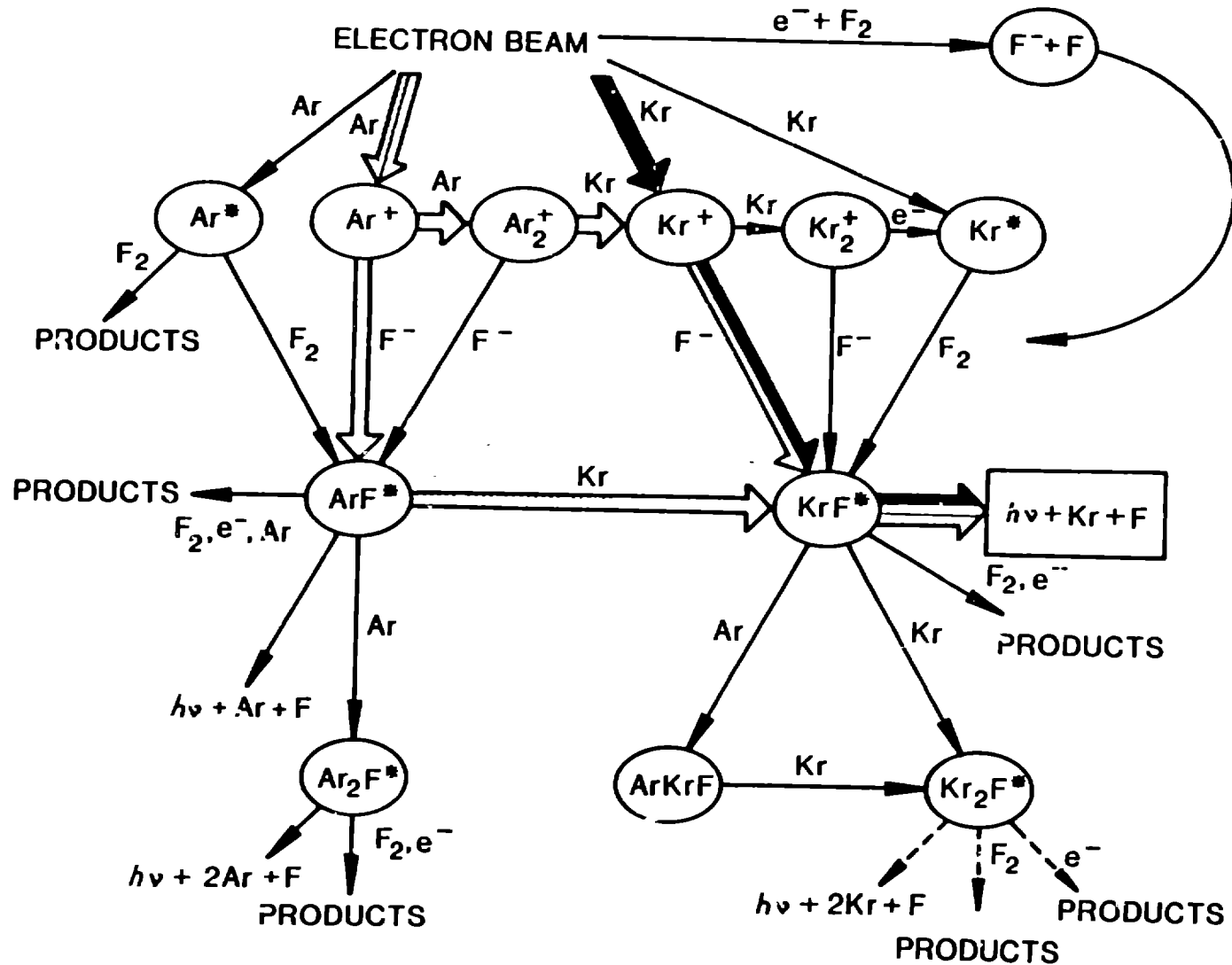

REDUCED ABSORPTION BY THE LASING MEDIUM ENABLES HIGHER EXTRACTION EFFICIENCY

